

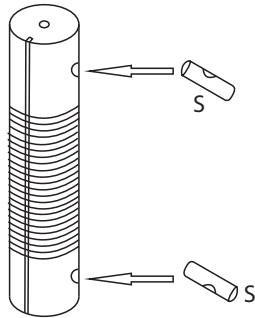

1



Insert Part S inside the 2 holes of each of the Posts, ensure the hole in the Part S is aligned with the internal thread of the Posts.

Stecken Sie jeweils die Teile S in die beiden Löcher der jeweiligen Stämme. Achten Sie bitte darauf, dass die Löcher der Teile S so ausgerichtet sind, dass sie mit dem Innengewinde des jeweiligen Stammes übereinstimmen.

2

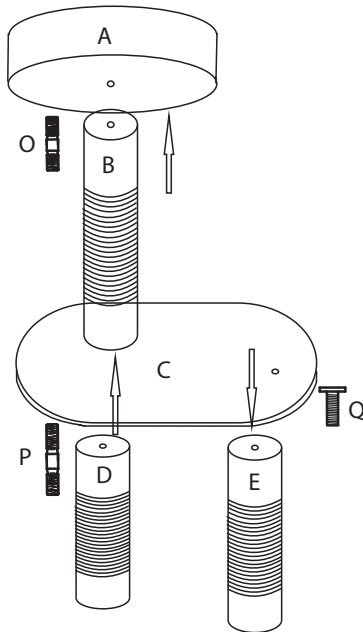



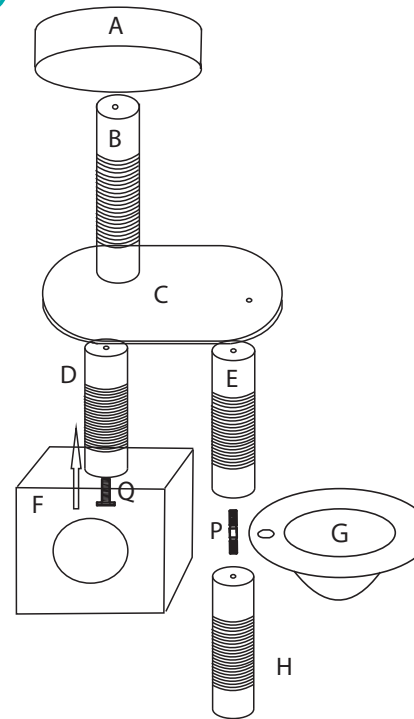

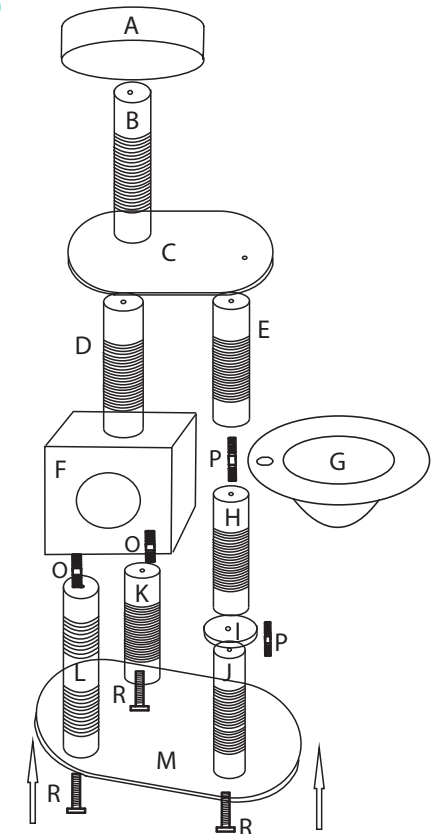

3

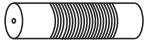



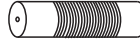

4



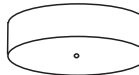

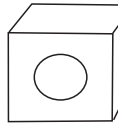

- 1x B  9x40 cm
- 1x D  9x35 cm
- 1x E  9x38 cm
- 1x H  9x36 cm

- 1x J  9x32 cm
- 1x K  9x45 cm
- 1x L  9x45 cm
- 1x I 

- 1x A 
- 1x C  40x35 cm
- 1x M  48x60 cm

- 1x F 
- 1x G 

- 3x O  Ø 8x50 mm
- 3x P  Ø 8x90 mm
- 2x Q  Ø 8x55 mm
- 3x R  Ø 8x60 mm
- 14x S 
- 1x T 